

2012
DODGE **CHARGER** //





DODGE CHARGER

EVEN THOUGH IT CASTS A SHADOW
THAT'S ALL ITS OWN,
CHARGER IS A VEHICLE THAT'S
DESIGNED TO STEP OUT OF ONE.
THE POWERTRAIN IS DESIGNED TO BE
EFFORTLESS ON THE HIGHWAYS
AND ENTHUSIASTIC OFF THE CORNERS, WHILE
ENGINE TECHNOLOGY
YIELDS PERFORMANCE WITH A CONSCIENCE.
TECHNOLOGY INTERTWINED WITH
A DOSE OF LEGEND,
THIS IS THE DRIVING EXPERIENCE THAT
ONLY CHARGER CAN DELIVER.

CHARGER STANDS OUT //

- ALL-NEW 8-SPEED AUTOMATIC TRANSMISSION
- BEST-IN-CLASS^{[1]*} 292-HORSEPOWER V6 AND BEST-IN-CLASS^[2] 31 HWY MPG
- MID-SIZE FUEL EFFICIENCY IN A FULL-SIZE CAR
- AVAILABLE DIE-CAST STEERING WHEEL-MOUNTED PADDLE SHIFTERS
- ALL-NEW 470-HORSEPOWER SRT8[®]
- AVAILABLE ALL-WHEEL DRIVE (AWD) ON V6 MODELS
- 2011 INSURANCE INSTITUTE FOR HIGHWAY SAFETY (IIHS) TOP SAFETY PICK

*A note about this brochure: All disclaimers and disclosures can be found on the inside back cover.





Charger R/T in Pitch Black.



Charger SXT Plus in Bright White.

NOW FOR A NOD TO THE PRESENT. Charger seamlessly merges modern, aerodynamic style with nods to its storied heritage. The sculpted body flaunts scalloped doors, a dual scalloped hood, and the Charger throwback styling. The signature Dodge grille features a distinct four-quadrant crosshair design with Black Satin inset and chrome surround. It's the perfect balance of blackout to brightwork. A laser-brazed roof eliminates roof ditch moldings for a purely premium appearance. Standard automatic quad halogen reflector headlamps with Gloss Black bezels or available low-beam High Intensity Discharge (HID) headlamps project light and attitude with equal authority. Available SmartBeam™ headlamps automatically and instantly adjust brightness and intensity when approaching forward lights from another vehicle are detected.



31 MPG // 292 HP

**3.6-LITER PENTASTAR® V6 –
NAMED ONE OF WARD'S 10 BEST ENGINES FOR 2011.**

The 3.6-liter DOHC Variable Valve Timing (VVT) Pentastar V6 engine draws on advanced automotive engine technology for outstanding power and an exceptional blend of high torque, best-in-class^[2] fuel economy of 31 hwy mpg with available 8-speed transmission, low emissions, and first-rate noise, vibration, and harshness (NVH) control. The numbers speak volumes – best-in-class^[1] standard V6 292 horsepower, 260 lb-ft of torque. The performance story only gets better when Charger's best-in-class^[1] horsepower is coupled with best-in-class^[2] 31 highway mpg; that's mid-size fuel efficiency in a full-size car.

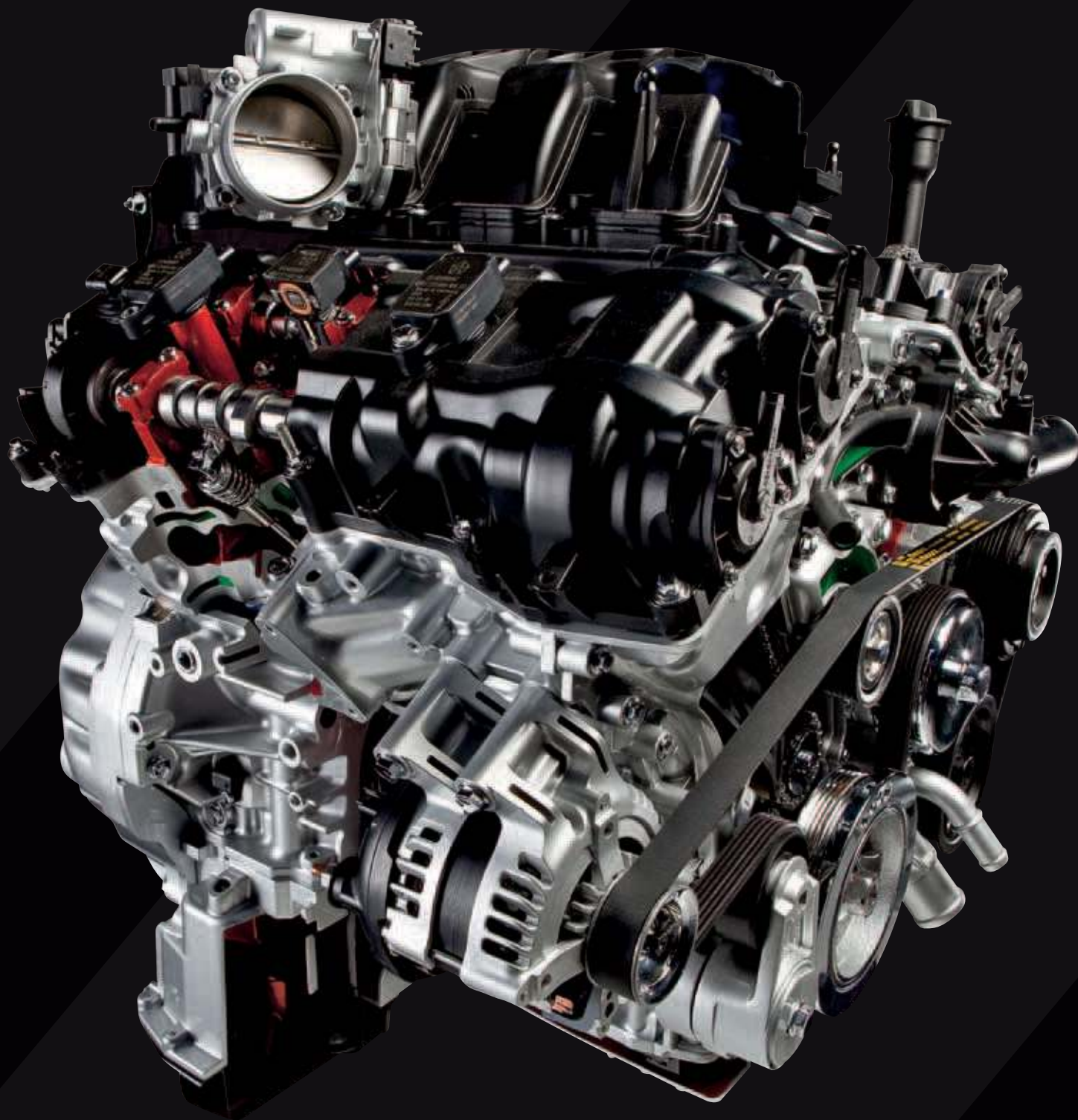

CLASS-EXCLUSIVE⁽¹⁾ 8-SPEED TRANSMISSION WITH E-SHIFT.

Dodge Charger ups the ante with an all-new 8-speed transmission engineered to improve fuel efficiency and performance. The transmission features two different shift programs: a standard pattern for everyday driving and a sport position for a more aggressive feel and extended shift points. The Sport Mode can also be used with the available all-new die-cast steering wheel-mounted paddle shifters, providing manual control.

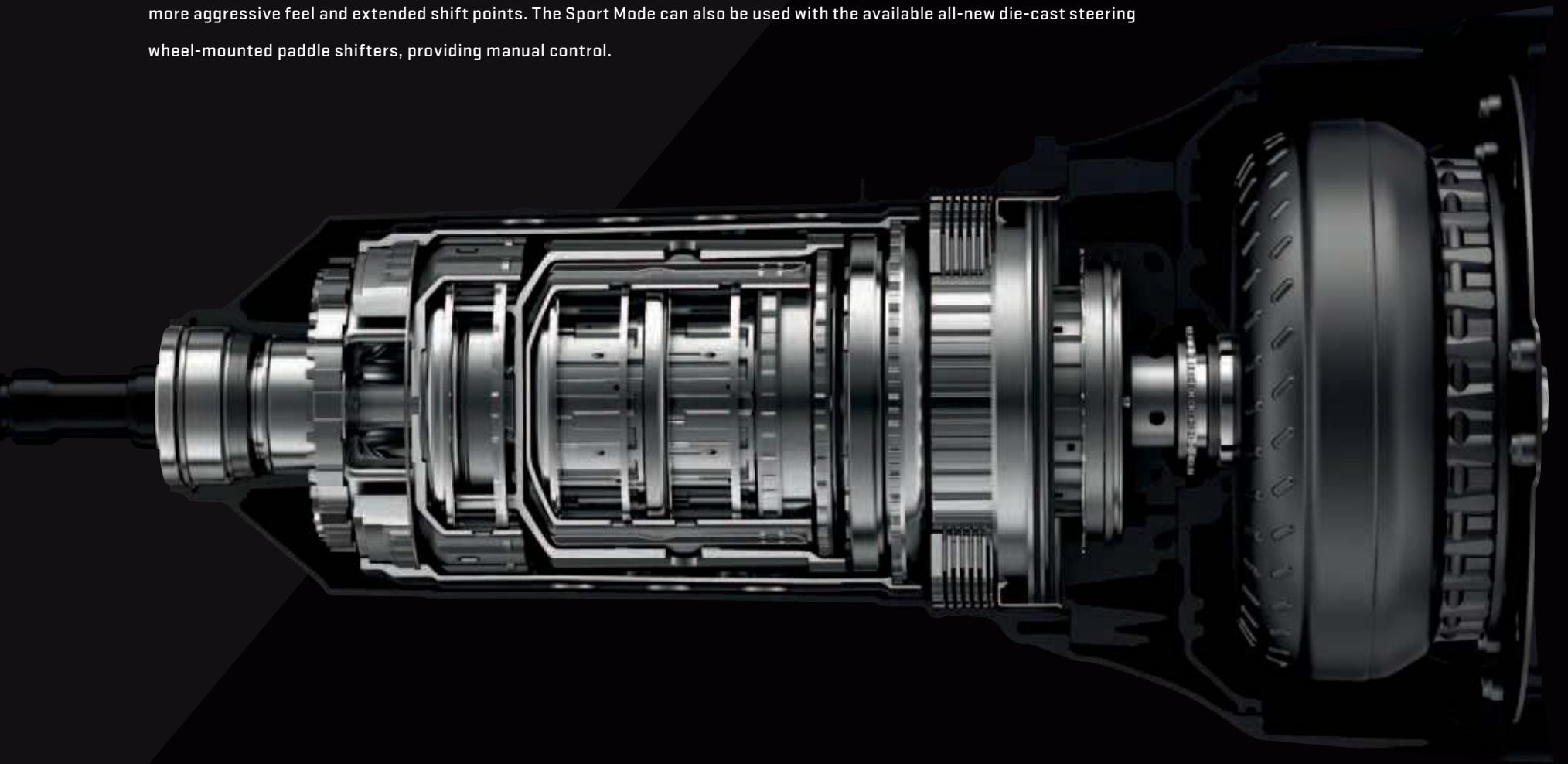

STATE-OF-THE-ART VARIABLE VALVE TIMING (VVT).

Designed for maximum durability and outstanding NVH control, the VVT employs cam phasing to change the timing of valve operation based on the engine's operating conditions. Cam phasing eliminates the fixed relationship between the intake and exhaust valves, and allows the greatest possible variance in valve timing. Through the use of electrohydraulic vane-type phasers, the camshaft is able to rotate over a 50-degree range in either direction eliminating the amount of overlap between the intake and exhaust valves. The result: improved efficiency, steady idle, smooth engine operation, more torque, and maximum horsepower when needed.

FUEL SAVER TECHNOLOGY

SPRINTS WITH A MARATHONER'S STAMINA. Think of this as technology that enables the legendary HEMI[®] engine to perform as well at the gas station as it does on the road. Fuel Saver Technology, standard on the 5.7-liter and 6.4-liter HEMI V8 engines, allows the engine to deactivate four cylinders based on driving input, when eight are not needed, creating the perfect combination of power and efficiency. When cruising at highway speeds the Fuel Saver Technology system uses advanced computer technology and electronic throttle control to transform the engine seamlessly from V8 power to an efficient four-cylinder power plant in 0.04 seconds.

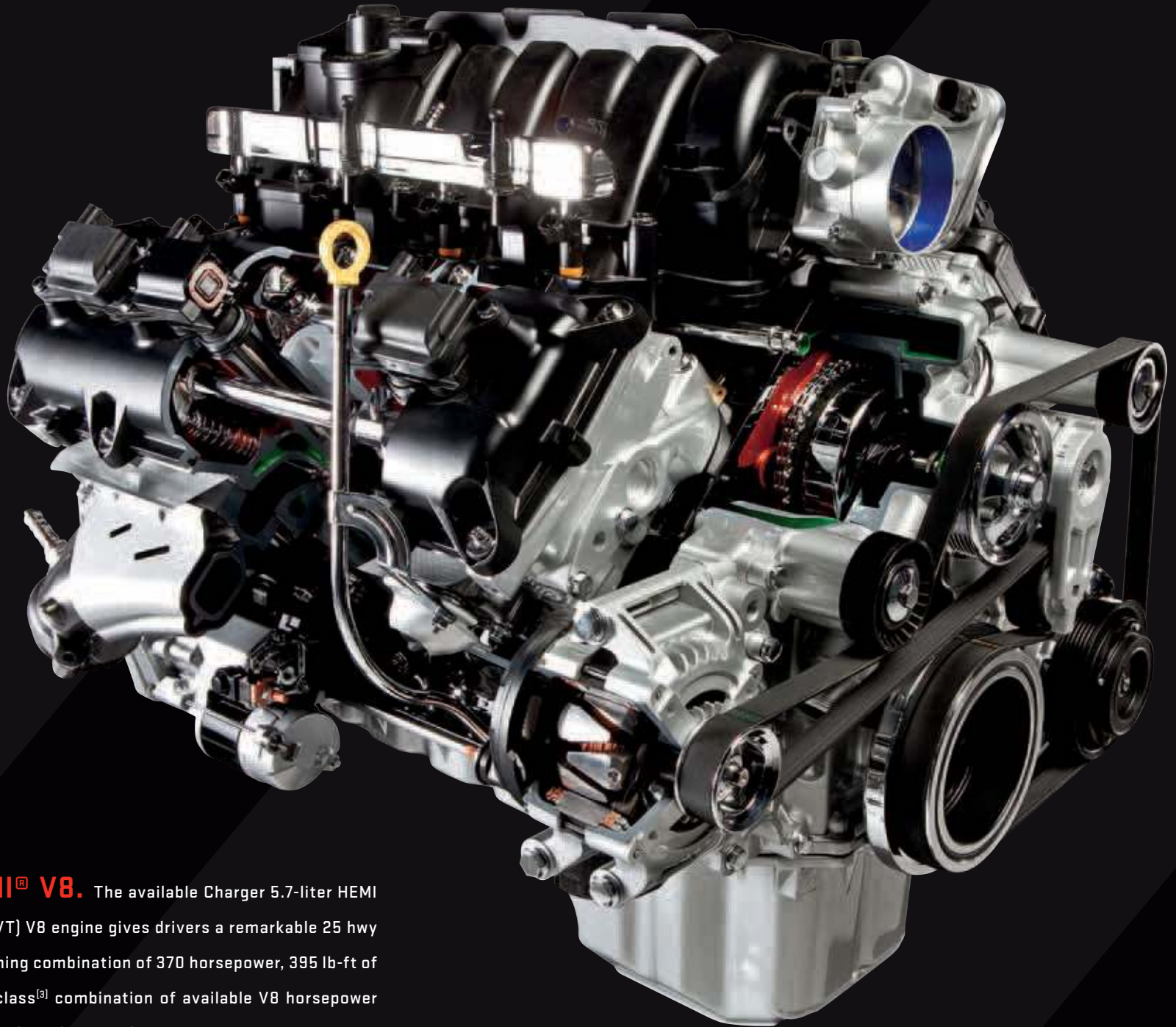

5.7-LITER HEMI[®] V8. The available Charger 5.7-liter HEMI Variable Valve Timing (VVT) V8 engine gives drivers a remarkable 25 hwy mpg. The result is a stunning combination of 370 horsepower, 395 lb-ft of torque, and the best-in-class^[3] combination of available V8 horsepower and fuel economy. Standard on Charger R/T.

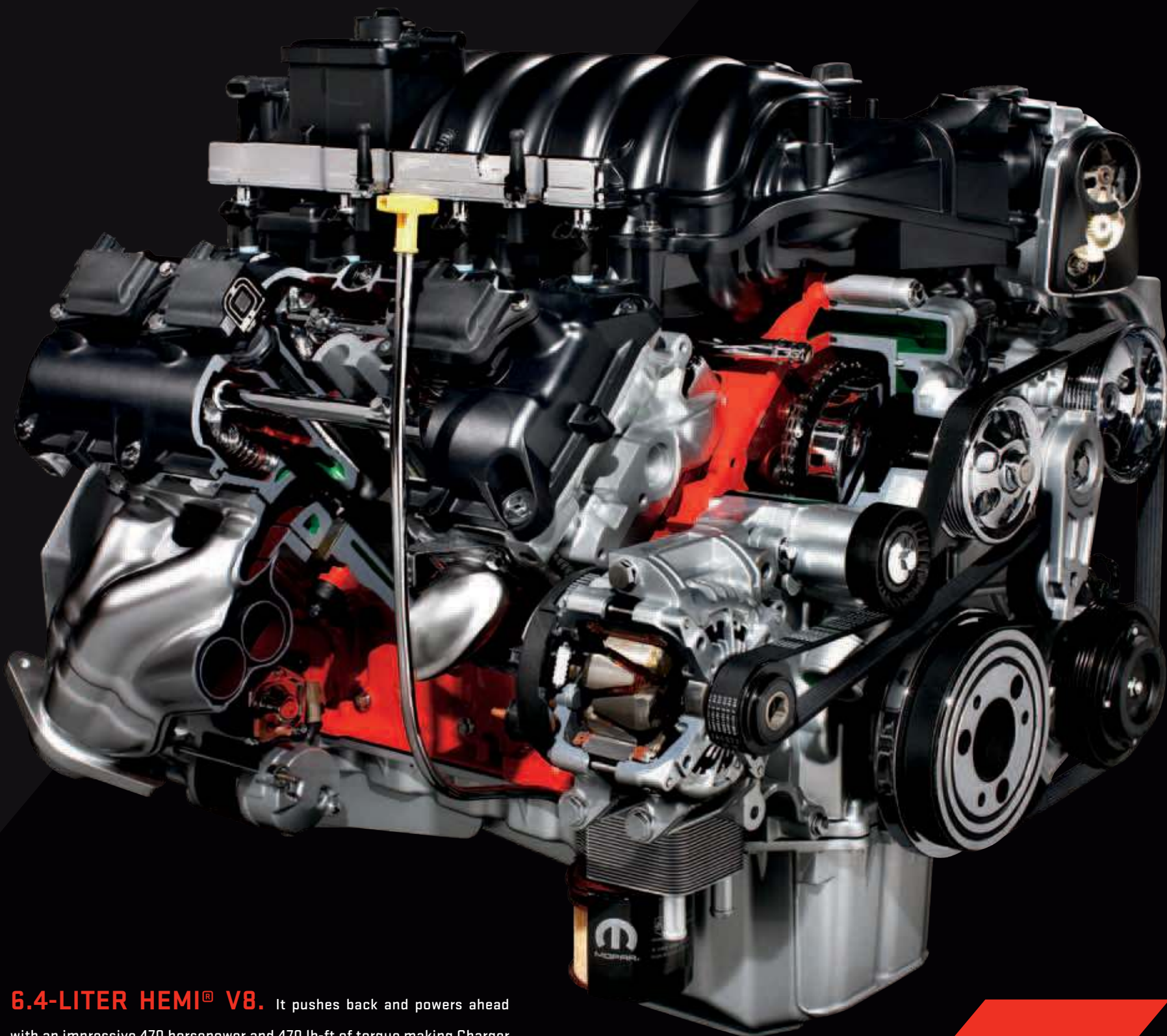

6.4-LITER HEMI[®] V8. It pushes back and powers ahead with an impressive 470 horsepower and 470 lb-ft of torque making Charger SRT8[®] the most powerful V8 sedan in its class.^[1] This power is engaged over a wider rpm range through the new Active Valve Exhaust System. An active intake manifold and high-lift camshaft with integrated cam phasing provide maximum low-end torque for impressive standing starts while optimizing high-end power. Standard on SRT8.





THE NEW HOT SPOT. Dodge Charger has always stood for standing out. The interior of the 2012 Charger is no exception. The design is influenced by a deep muscle car heritage while the comfort and exceptionally designed details are all 21st century. Seat surfaces are covered in either premium cloth or available Nappa leather trim. All pillars are wrapped in fabric, which speaks volumes to craftsmanship and refinement. Armrests, door trim panels, and the instrument panel all feature soft-touch materials. Stunning LED lighting illuminates the door pulls, center console, and cup holders, and is available in the footwells, map pockets, and overhead console. A uniquely executed aluminum bezel framework for the entire instrument panel cluster provides a seamless flow-through uniformity to its design and encompasses the available 8.4-inch touch screen, the largest in its class.^[1] Leave it to Charger to impose a powerful presence inside and out.



MISSION? CONTROL. While the performance is aggressive, the cabin was designed to be inviting. Immediately you'll notice the premium soft-touch materials, available distinct interior color combinations, and upscale accent finishes. Less noticeable but truly impactful are touches like the dual-laminated windshield and front-door side glass, body-cavity silencing foam, under-flush roll-framed doors with triple seals, and noise-dampening lined wheel wells that work together to keep the cabin quiet. The ride is made even more enjoyable by available heated front and rear seats, a standard six-way power driver's seat, or the available 12-way driver and front-passenger seats. Standard 60/40 split-folding rear seats with available heat offer not only great flexibility, but comfort too. Available features include new sport seats, in leather or cloth, and high-performance leather-trimmed seats with ventilation on SRT8® and R/T Road & Track. [Late availability.]

[1] Experience the latest in automotive technology with the available all-new 8-speed transmission coupled with a new E-shifter or available die-cast steering wheel-mounted paddle shifters for manual shifting capability. Let your hands and eyes wander, noticing the tremendous attention to detail. The center console lifts for the easy access of all passengers and has space for change, travel essentials, and has multiple ports (aux, 12-volt, and USB) for personal electronic devices. A tambour door leads to dual illuminated cup holders with available cooled/heated cup holders that work independently of each other.

[2] The sculpted instrument panel features a premium soft-touch finish. A seamless, real billeted aluminum bezel insert runs through the instrument panel, and is used in the center console bezel for a race-inspired feel. All steering wheels have front-mounted backlit cruise and EVIC/customer-programmable display controls, and audio controls located on the rear surface. Opt for the available full-circumference heated steering wheel and keep your hands warm on even the coldest of mornings.



1



2



Charger SRT8® in Tungsten Metallic.

SRT



CHARGER SRT8.[®] This is not an experiment. This is not an appearance package that's been influenced by anything superficial. No, this is the most powerful V8 sedan in its class,^[1] tightly packaged in the unmistakable skin of a Charger. An intense 470 horsepower and 470 lb-ft of torque arrive courtesy of a 6.4-liter HEMI[®] V8 engine. Charger SRT8 stands out with a proprietary fascia with an aggressive air intake and culminates with a rear spoiler sworn to keep this vehicle firmly planted. Unique rear styling, side sill trim, and new 20-inch split-spoke forged aluminum SRT[®] design wheels complete a package that's built to perform. Hinting at the power lurking beneath is a standard air exhauster in the hood for improved engine cooling, and enormous twin four-inch round dual exhaust outlets. The interior is equally fierce. A new leather-wrapped, heated, flat-bottom, SRT logo three-spoke steering wheel with contoured palm rests eagerly waits for hands to grip it. Other SRT features include: heated and ventilated high performance-bolstered front seats with suede inserts; special bolstering on door panels; dark engine turn aluminum IP cluster and shifter bezel accents; die-cast steering wheel-mounted paddle shifters; customer-selectable "Sport" mode. Drivers can keep track of their stats via a new liquid crystal color graphic Electronic Vehicle Information Center (EVIC) and 8.4-inch touch screen – housing performance pages that can be customized to view driver preferences as well as instant feedback on steering input, horsepower, torque, and additional engine info such as 0-60 time, 60-0 braking, g-forces, and quarter-mile times. Even the sound system exudes amped-up attitude with an available Harman/Kardon,[®] 900-watt, 19-speaker surround sound system. Get more at driveSRT.com





CONTROL FREAKS. The class-exclusive^[1] five-link rear suspension geometry is engineered for a performance-oriented sport-tuned ride, excellent body and wheel control, optimized road surface contact, and engaging handling prowess. The touring and performance-tuned Charger gets even with its impressive powerhouse engines and tops it off with notable suspension and chassis refinement. The front suspension provides a smooth ride and performance. A low and large shock-and-sway application reduces harshness over bumps and improves durability. All Chargers are packed with standard control offerings like ABS, Hill Start Assist, Ready Alert Braking, two modes of Electronic Stability Control (ESC),^[4] Traction Control, Brake Assist, and Rain Brake Support.

The twin piston, four-wheel antilock disc brake system (ABS) is performance-tuned to provide improved ABS response, maximum stopping power, and reduced pedal travel. The standard four-wheel disc brakes bring substantial braking power with antilock and Brake Assist. The results of all this engineering are reduced resistance and enhanced long-term braking performance.

Charger R/T AWD in Tungsten Metallic.



A GRIPPING TALE.





MOST ADVANCED ALL-WHEEL-DRIVE SYSTEM ITS CLASS^[1] – NOW AVAILABLE ON V6 AND V8 MODELS. Opt for all-wheel drive (AWD) with automatic front axle disconnect on Charger SXT and R/T models, and the system seamlessly transitions between rear-wheel drive and AWD with no driver intervention. The system provides power on demand between the front and rear differentials as needed. When AWD is not required, the system automatically disconnects the front axle and opens the transfer case from the drivetrain to reduce friction and rotational mass and maximize fuel efficiency. AWD is automatically triggered under a number of scenarios: when wheel slip is detected, AutoStick mode is engaged, the ESC^[4] system is turned off, the windshield wipers are activated, or the temperature is below 37°. Chrysler Group LLC is the only manufacturer to offer AWD with an active transfer case and front axle disconnect. AWD is available on V6 models (SXT, SXT Plus) equipped with the new 8-speed transmission as well as V8 models (R/T, R/T Plus, R/T Max) with the 5-speed transmission.





TECHNOLOGY THAT KNOWS YOU. Outfit your Charger with Uconnect® to help stay in touch with the people, music, and devices that matter most. It acts as the central location for your most important media – cell phone, Internet, SiriusXM™ Satellite Radio,^[5] navigation system, and personal devices, such as an iPod® or smartphone. The Uconnect user-friendly system allows you to stay connected, informed, entertained, and focused on driving.

 **ENTERTAINMENT.** Manage all of your media. You'll have multiple ways to access audio, including SiriusXM Satellite Radio^[5] (your first year of service is included), iPod control with Voice Command,^[7] Bluetooth® streaming audio, audio input jack, CD, SD card slot, and radio.

 **PHONE.** Talking on the phone while driving has never been easier – or more responsible. Uconnect Phone is the in-vehicle, voice-activated communication system that allows you to pair up to seven Bluetooth compatible phones and then talk virtually hands-free. This system is also clever enough to synchronize with your phone's address book^[6] – up to 1,000 entries – so you can call whoever you want by simply saying their name.

 **NAVIGATION.** Select destination entries by using voice commands and receive turn-by-turn guidance with voice prompts and visual displays. It can also locate nearby restaurants, shopping, hospitals, or points of local interest.

 **VOICE COMMAND.^[7]** It simplifies driving by letting you keep your eyes on the road and your hands on the wheel. Use your voice to select AM/FM radio stations, SiriusXM Satellite Radio^[5] channels, make calls, and record voice memos. This smart system technology can also be trained to better recognize your voice and can understand commands in English, French, and Spanish.

 **WEB.** Put the power of high-speed Internet in your vehicle with Uconnect Web.^[6] Effortlessly connect any WiFi-enabled device to the Internet at 3G broadband speeds, making your vehicle a mobile Hotspot. Passengers can use multiple devices at the same time. There's no need for cell cards or software with this unique Authentic Accessory by Mopar® – it's all wireless. Subscription required. Sold separately.

UCONNECT MEDIA CENTER RADIOS

AVAILABLE	Uconnect TOUCH™ 8.4N	Uconnect TOUCH 8.4	Uconnect TOUCH 4.3S	Uconnect TOUCH 4.3
Charger SRT8®	S			
Charger R/T Max	S			
Charger R/T Road & Track	O	S		
Charger R/T Plus	O	S		
Charger R/T	O	S		
Charger SXT Plus	O	S		
Charger SXT	O	S		
Charger SE			O	S
SELECTED FEATURES				
LCD Display	8.4-inch Touch Screen	8.4-inch Touch Screen	4.3-inch Touch Screen	4.3-inch Touch Screen
Optical Drive	CD/DVD/MP3	CD/DVD/MP3	CD/MP3	CD/MP3
Navigation	Garmin®			
SiriusXM Travel Link™ ^[5]	S			
SiriusXM Traffic™ ^[5]	S			
SiriusXM Satellite Radio ^[5]	S	S	S	
Storage	SD Card	SD Card		
Audio Input Jack	S	S	S	S
Hands-Free Voice Command of Phone, ^[7] Radio, Players	O	O	O	O
Bluetooth Streaming Audio	O	O	O	O
USB Port for Digital Media Storage/ Players (iPod)	S	S	S	S

S = Standard. O = Optional.

SiriusXM TRAVEL LINK™^[5]

Brings a wealth of useful information to your fingertips, including national weather forecasts, fuel prices for local gas stations, in-game and final sports scores, weekly sports schedules, local movie theater listings, and even local ski slope conditions. Subscription required after one-year included service.

SiriusXM TRAFFIC™^[5]

Don't drive through traffic, drive around it. SiriusXM Traffic delivers comprehensive traffic information directly to your vehicle. This includes continuously updated information on traffic speed and flow, accidents, construction, and road closures.



Join fellow Dodge enthusiasts and tell your story by posting comments, participating in discussions, and sharing your photos and videos. Join our community on Facebook, follow us on Twitter, and check us out on YouTube.

A BRILLIANT LACK OF BRIGHTWORK. Charger Blacktop Package builds off the Charger SXT and SXT Plus trim levels with a 292-horsepower V6 and 8-speed automatic transmission, while putting its own spin on the details. Standard features include Gloss Black grille with Black honeycomb insert, performance suspension, P245/45R20 BSW AS performance tires, 20-inch Black painted aluminum wheels, steering wheel-mounted paddle shifters, customer selectable Sport mode, Beats™ Audio Group* featuring 10 speakers with subwoofer and 552-watt amplifier, and Sport cloth or Sport leather-trimmed bucket seats depending on model. Available only in Tungsten Metallic, Bright Silver Metallic, or Pitch Black. *Late availability.







SAFETY.

Safety and security are the driving principles behind every Dodge vehicle, including Charger. **RAIN BRAKE SUPPORT.** During rainy conditions and when the vehicle's wiper system is activated, the ESC^[4] system conditions the rotors, allowing optimal operation. **AIR BAGS.**^[9] Advanced multistage front air bags, supplemental front-seat mounted pelvic-thorax side air bags, driver-side knee air bag,^[9] and supplemental side-curtain air bags^[9] for front and rear outboard occupants are all standard. **TIRE PRESSURE MONITORING.** Standard pressure sensors in the tire valves allow automatic detection and notification when tire pressure is low. **REACTIVE HEAD RESTRAINTS.**^[10] In the event of a rear collision, these standard head restraints^[10] help to reduce the chance of injury for front-seat occupants. **ELECTRONIC STABILITY CONTROL (ESC).**^[4] A standard vehicle-wide network of safety sensors provides instant aid when it detects that you're veering off your intended path. This robust system includes antilock brake system (ABS) with Brake Assist and all-speed traction control. **READY ALERT BRAKING (RAB).** The system anticipates situations when the driver may initiate an emergency brake stop and uses the ESC pump to pre-charge the brake system in order to decrease the time required for full brake application. **BRAKE ASSIST.** When the system senses that a panic braking event is occurring, it provides increased braking pressure for optimal stopping distances. **IMPROVED CRUSH ZONES.** Designed to divert and dissipate impact energy away from the passenger compartment, helping minimize injuries in the event of an accident. **INTELLIGENT BATTERY SENSOR (IBS).** This standard system continually measures the flow of current into and out of the battery. This enables "intelligent load shedding," which systematically shuts off the vehicle's electrical systems if the battery is running low, to help prevent a driver being stranded due to a low or depleted battery. When IBS conducts load shedding, an icon appears in the cluster display. **SENTRY KEY® ENGINE IMMOBILIZER.** The vehicle is prevented from starting unless the key fob containing a unique embedded code is present. **HILL START ASSIST.** Automatically applies the brakes momentarily to help prevent rollback on hills and inclines.

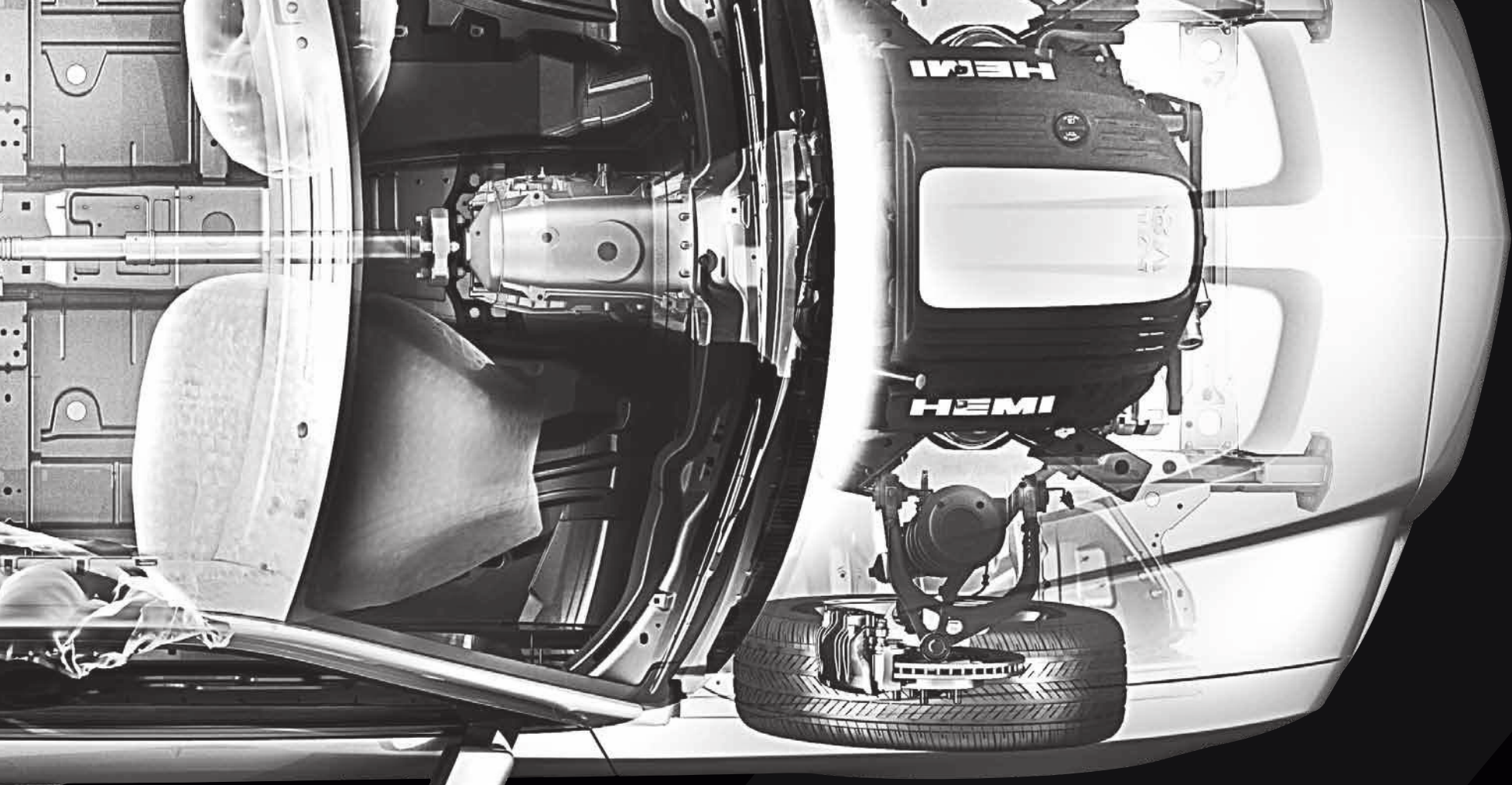

DESIGN

**CHARGER – A 2011 INSURANCE INSTITUTE FOR
HIGHWAY SAFETY (IIHS) TOP SAFETY PICK.**



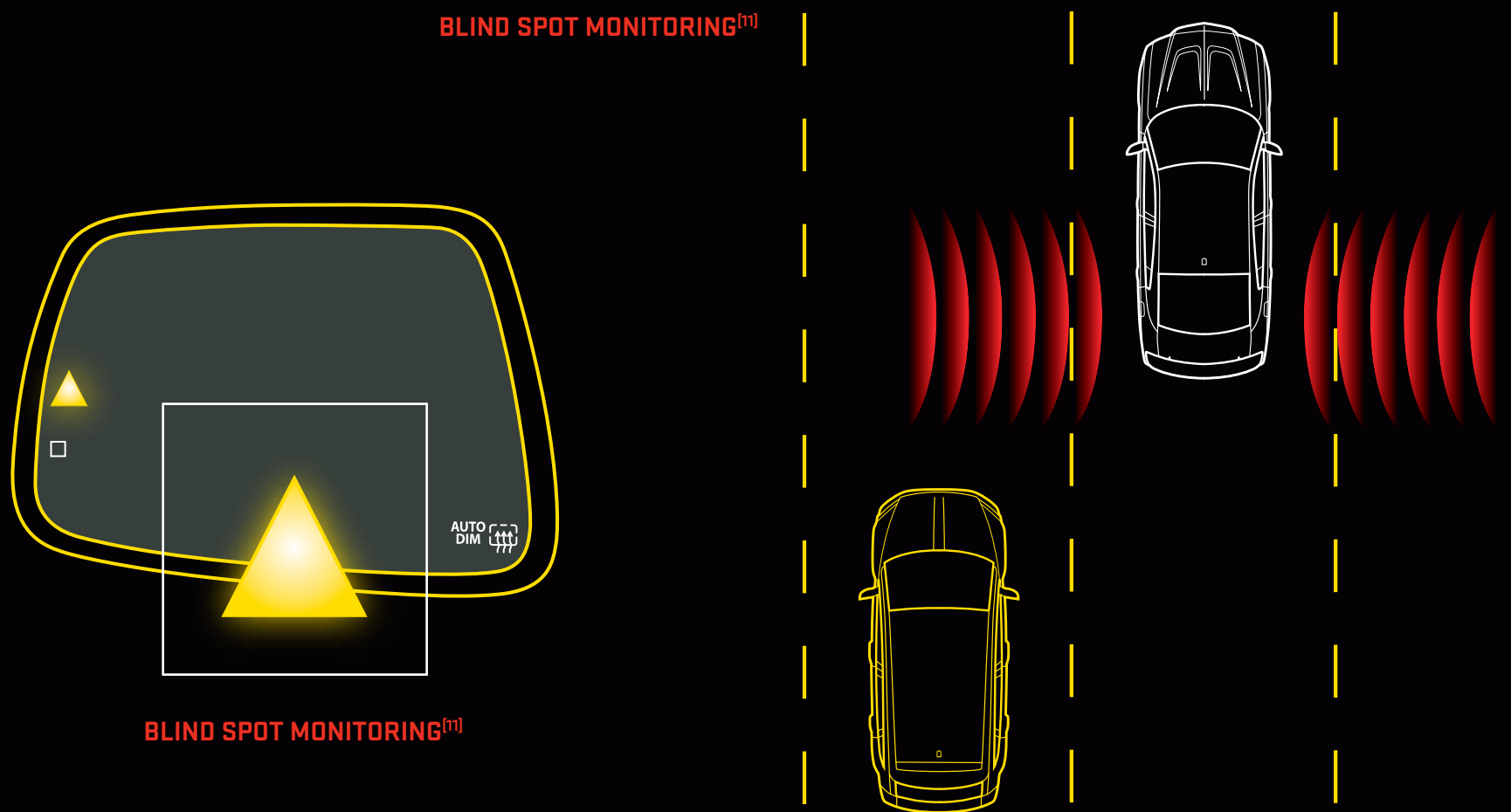
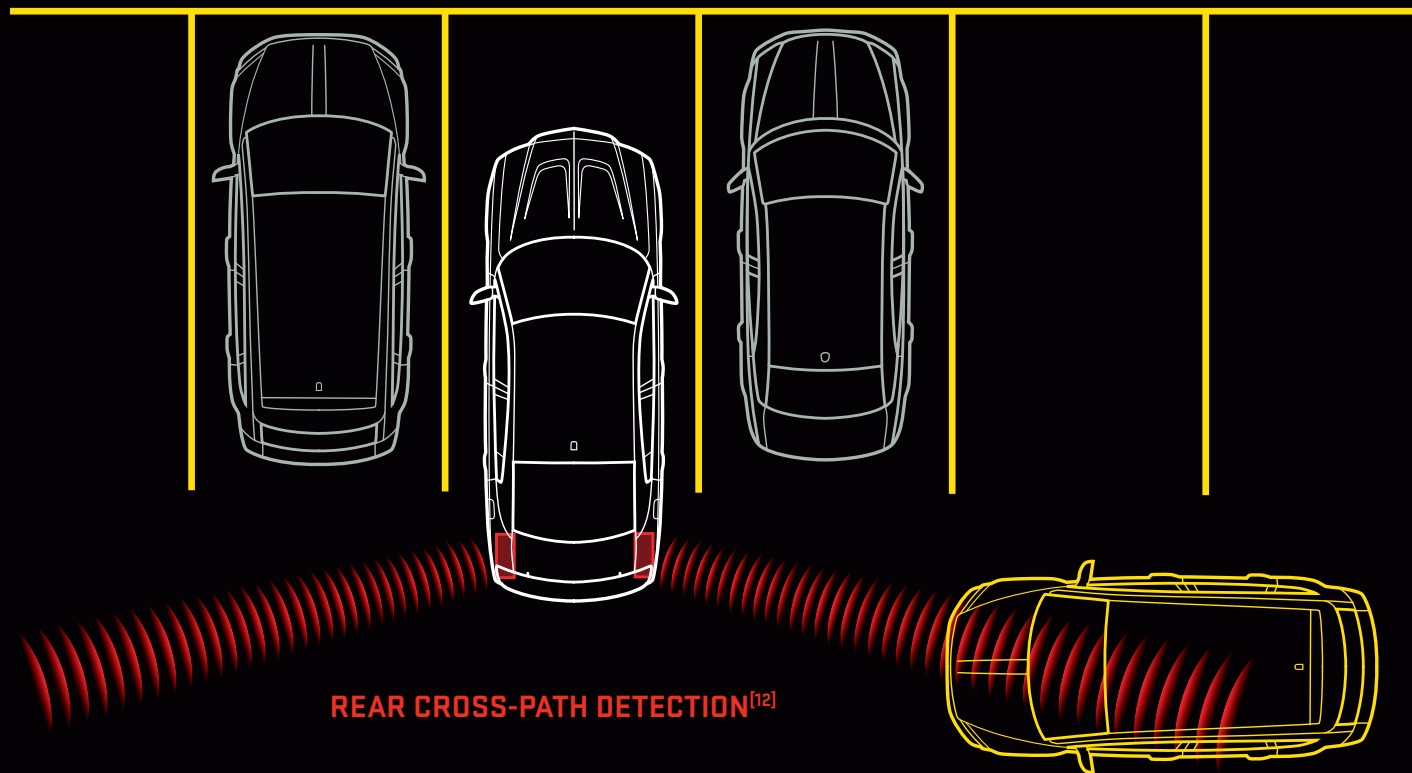

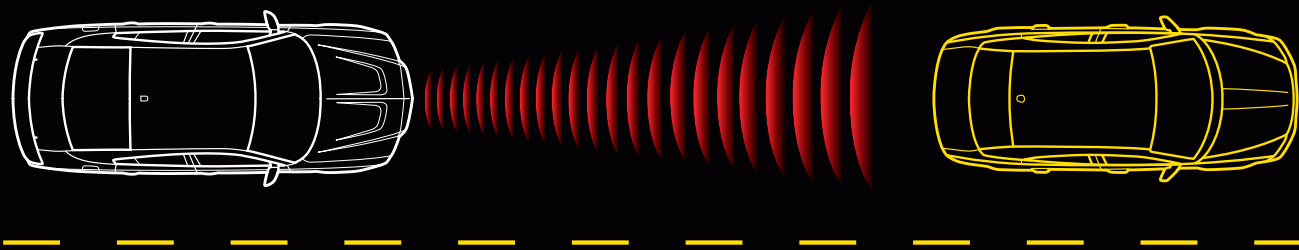

ADAPTIVE CRUISE CONTROL ^[13]

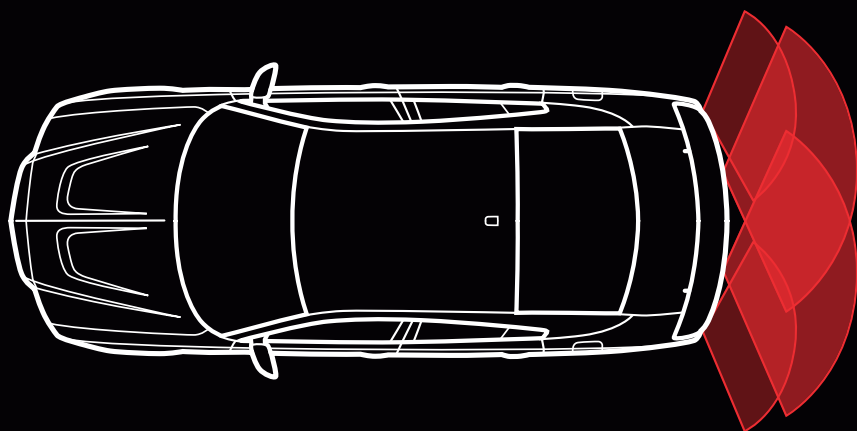

PARKSENSE® REAR PARK ASSIST SYSTEM ^[12]

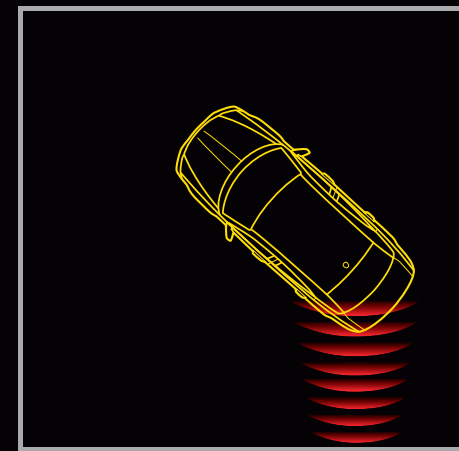

FORWARD COLLISION WARNING ^[14]

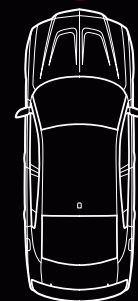

UNCOMMON SENSORS. Its brilliant blend of 21st-century technology and smart engineering give Charger the best in automotive innovations. **KEYLESS ENTER 'N GO.** This technology automatically unlocks doors when the vehicle is approached and the exterior handle is pulled, instead of having to fumble for a key fob. Once inside, a simple press of the Start/Stop button and brake pedal brings the Charger engine to life. **BLIND SPOT MONITORING (BSM)^[11] WITH REAR CROSS-PATH DETECTION.^[12]** Dual radar sensors constantly monitor driver blind spots, providing notification of an encroaching vehicle via illuminating icons on the sideview mirrors and by audible chime. The system also includes Rear Cross-Path Detection,^[12] which monitors for vehicles/objects in perpendicular relationships to the vehicle while backing out of tight parking spots. Available. **PARKSENSE® REAR PARK ASSIST SYSTEM.^[12]** When in Reverse, sensors detect the presence of objects within 6.5 feet in the backup pathway and provide both an audible chime and a visual warning. Available. **ADAPTIVE CRUISE CONTROL (ACC).^[13]** Automatically adjusts cruising speed to maintain a preset distance between your vehicle and the one ahead. Available. **FORWARD COLLISION WARNING (FCW).^[14]** Radar sensors detect when a vehicle may be approaching an object too rapidly, alerting driver with both an audible chime and a visual warning. Available. **RAIN-SENSITIVE WIPERS.** System sensors automatically detect moisture on the windshield and activate wipers. Available. **SMARTBEAM™ HEADLAMPS.** Low-beam High Intensity Discharge (HID) headlamps automatically adjust to oncoming traffic to keep the lamps focused on the road ahead. Available. **REMOTE START.** The available Smart Remote Start system operates from as far as 200 feet. It starts the vehicle via fob activation, as well as activates the climate control and the available heated seats and heated steering wheel, depending on temperatures outside and inside the vehicle.

AUTHENTIC DODGE ACCESSORIES

Charger R/T Plus in Redline 3 Coat Pearl shown with Authentic Dodge Accessories by Mopar[®], including 20-inch Classic Wheels, Bodyside Stripe Decal Kit, Rear Spoiler, Black Chrome Grille Surround, and Lower Front Fascia Air Dam. See your dealer for a brochure of the full line of Authentic Accessories for your Dodge Charger.



ADD YOUR FINISHING TOUCH. Mopar inspires vehicle owners with innovative parts and accessories – all made-to-spec for your Charger. This is what Mopar delivers, along with expert, caring service. Mopar technicians are the masters of your make and model, with access to the tools and diagnostic equipment that help get the job done efficiently. Choose authentic Mopar parts and service, and you'll drive away with peace of mind. Find out more at mopar.com

STYLE // Move up. Custom Wheels and Katzkin Leather Seats from Mopar only start the palette of accessories to enhance your vehicle's appearance and express your individuality.

PERFORMANCE // Power and driving precision are balanced by appealing performance-inspired products, like Engine Covers, Shifters, Fascia Air Dams, and Spoilers.

SPORT // There's a definite look to the sporting life. Body Decals, dynamic Graphics, and even Custom Steering Wheels give your Charger bold presence and personality.

PROTECTION // Safeguard your vehicle with smart accessories like Door Sill Guards and Slush Mats – made precisely for the protection and security of your ride.

INNOVATION // From Uconnect Web^[9] to an Electronic Vehicle Tracking System, the latest Mopar technology can enhance and expand your driving experience.

CHARGER SE



POWERTRAIN

3.6L Pentastar® VVT V6 engine, 5-speed AutoStick transmission
292 horsepower and 27 mpg highway

FEATURES

SELECTED CHARGER SE STANDARD EQUIPMENT:

- 17-inch aluminum wheels
- LED rear taillamps
- Dual rear exhaust with bright tips
- Premium cloth seating
- Uconnect Touch™ with 4.3-inch touch screen, CD/MP3 and six speakers
- Electronic Stability Control (ESC)^[4] including: Hill Start Assist, Ready Alert Braking, all-speed traction control, Brake Assist, and Rain Brake Support
- Reactive front head restraints^[10]
- Seven standard air bags^[9]
- Four-wheel disc antilock brakes
- Air conditioning with Dual-Zone Temperature Control and humidity sensor
- Keyless Enter 'n Go with proximity sensor
- Power six-way driver seat
- 60/40 split-folding rear seat
- Tilt/telescoping steering wheel with cruise/audio controls
- Acoustic windshield and front-door side glass
- Illuminated front cup holders

CHARGER SXT



POWERTRAIN

3.6L Pentastar VVT V6 engine, 8-speed transmission with E-shifter
292 horsepower and 31 mpg highway

FEATURES

DIFFERENCES/UPGRADES VS. SE:

- Fog lamps
- Uconnect Touch with 8.4-inch touch screen
- Manual folding, heated, power adjustable exterior mirrors
- Dual-Zone Automatic Temperature Control with humidity sensor
- Heated front seats
- Uconnect® hands-free communication with Voice Command^[7]
- Auto-dimming rearview mirror with microphone
- SiriusXM™ Satellite Radio^[6] with one-year subscription
- Six premium speakers with 276-watt amplifier
- 12-way power driver's seat
- Leather-wrapped steering wheel and shift knob
- Remote start
- Universal garage door opener
- Front and rear LED-lighted map pockets
- 19-inch aluminum wheels – AWD models

CHARGER SXT PLUS

POWERTRAIN

3.6L Pentastar VVT V6 engine, 8-speed transmission with E-shifter
292 horsepower and 31 mpg highway

FEATURES

DIFFERENCES/UPGRADES VS. SXT:

- 18-inch chrome-clad wheels
- 19-inch aluminum wheels – AWD models
- Nappa leather-trimmed seats
- 12-way power driver and front-passenger seats
- Heated second-row seats with illuminated cup holders
- Driver and front-passenger lower LED lamps
- Front overhead LED lighting
- Security alarm
- Illuminated, heated, and cooled front cup holders



CHARGER R/T



POWERTRAIN

5.7L HEMI® VVT V8 with Fuel Saver Technology, 5-speed AutoStick transmission
370 horsepower

FEATURES

DIFFERENCES/UPGRADES VS. SXT:

- 18-inch aluminum wheels
- 19-inch aluminum wheels – AWD models
- Performance suspension and exhaust
- High Intensity Discharge (HID) headlamps
- Sport front seats
- Performance suspension
- Performance exhaust

CHARGER R/T PLUS

POWERTRAIN

5.7L HEMI® VVT V8 with Fuel Saver Technology, 5-speed AutoStick transmission
370 horsepower

FEATURES

DIFFERENCES/UPGRADES VS. R/T:

- 18-inch chrome-clad wheels
- 19-inch aluminum wheels – AWD models
- Nappa Sport leather-trimmed seats
- 12-way power driver and front-passenger seats
- Heated second-row seats
- Driver and front-passenger lower LED lamps
- Front overhead LED lighting
- Security alarm
- Illuminated, heated, and cooled front cup holders

CHARGER R/T ROAD & TRACK



POWERTRAIN

5.7L HEMI® VVT V8 with Fuel Saver Technology, 5-speed AutoStick transmission
370 horsepower

FEATURES

DIFFERENCES/UPGRADES VS. R/T PLUS:

- High-performance leather seats with perforated suede inserts
- Heated and ventilated front seats
- 3.06 axle ratio
- Paddle shifters
- 20-inch chrome-clad wheels
- Auto-dimming driver's side mirror with auto-adjust in Reverse
- Driver memory seat, mirrors, and radio
- Power tilt and telescoping heated steering wheel
- Power adjustable pedals with memory
- Four-wheel disc antilock performance brakes
- Six premium speakers with 276-watt amplifier
- High-speed engine controller
- Retro R/T badging
- Rear body-color spoiler



CHARGER R/T MAX



POWERTRAIN

5.7L HEMI® VVT V8 with Fuel Saver Technology, 5-speed AutoStick transmission
370 horsepower

FEATURES

DIFFERENCES/UPGRADES VS. R/T PLUS:

- 20-inch chrome-clad aluminum wheels
- 19-inch aluminum wheels – AWD models
- Nappa perforated leather-trimmed seats with ventilation (late availability)
- Driver Confidence Group including Blind Spot Monitoring (BSM),^[11] Rear Cross-Path Detection,^[12] ParkSense® Rear Park Assist System,^[12] SmartBeam™ headlamps, Rain-sensitive wipers and more
- Driver Convenience Group including Power adjustable pedals, power tilt/telescoping steering wheel, memory system
- Adaptive Cruise Control (ACC)^[13]
- Forward Collision Warning (FCW)^[14]
- Beats™ Audio Group including 10 amplified speakers with subwoofer and 552-watt amplifier (late availability)

CHARGER SRT8®



POWERTRAIN

6.4L HEMI® VVT V8 with Fuel Saver Technology, 5-speed AutoStick transmission
470 horsepower

FEATURES

DIFFERENCES/UPGRADES VS. R/T ROAD & TRACK:

- High-performance leather seats with perforated suede inserts with SRT® logo
- 20-inch forged aluminum wheels
- Unique front and rear fascias
- Functional hood scoop, monochromatic exterior
- Dark engine turn aluminum interior accents, bright pedals
- Uconnect Touch™ 8.4N Media Center with Garmin® GPS Navigation and SRT® performance pages
- ParkView® Rear Back-Up Camera^[12]/ParkSense® Rear Park Assist^[12]
- Two-mode adaptive damping suspension
- 19-speaker SRT® high-performance audio

AVAILABLE OPTIONS:

- Connectivity Group (SE)
- Uconnect Touch 4.3S Media Center (SE)
- 8-speed automatic transmission (SE)
- Blacktop Package (SXT, SXT Plus)
- Rallye Appearance Group (SXT, SXT Plus)
- Rear body-color spoiler (SXT, SXT Plus, R/T, R/T Plus, R/T Max)
- Driver Confidence Group (SXT, SXT Plus, R/T, R/T Plus, R/T Road & Track, SRT8)
- Power sunroof (All except SE)
- Adaptive Cruise Control^[13] (SXT Plus, R/T Plus, R/T Road & Track, SRT8)

- Beats™ Audio Group (R/T Road & Track) (late availability)
- Wheels (20-inch chrome-clad) and Tunes Group (R/T, R/T Plus)
- Super Track Pak (R/T Road & Track)
- 20-inch forged aluminum wheels (R/T Road & Track)
- Driver Convenience Group (SXT Plus, R/T Plus)
- All-wheel drive includes 19-inch aluminum wheels (SXT, SXT Plus, R/T, R/T Plus, R/T Max)
- Navigation/Rear Back-Up Group (SXT, SXT Plus, R/T, R/T Plus, R/T Road & Track)
- Black Front Fascia Accent Delete (SRT8)



CHARGER FABRICS



CHARGER SE, SXT, R/T //

(A) Gradual mesh/Carolina cloth – Black (standard) (B) Gradual mesh/Carolina cloth – Light Frost Beige (standard)

CHARGER SXT PLUS, R/T PLUS, R/T MAX //

(C) Nappa leather-trimmed/Caprice – Black* (standard) (D) Nappa leather-trimmed/Caprice – Tan* (standard) (E) Nappa leather-trimmed/Caprice – Radar Red* (standard)

CHARGER R/T ROAD & TRACK //

(F) Nappa leather-trimmed/Caprice with perforated suede inserts – Black (standard)

CHARGER SRT8® //

(F) Nappa leather-trimmed/Caprice with perforated suede inserts – Black (standard) (G) Nappa leather-trimmed/Caprice with perforated suede inserts – Radar Red (standard)

*Optional ventilated seats come with perforated leather surfaces.

CHARGER WHEELS

CHARGER SE //

(1) 17-inch aluminum (standard)

CHARGER SXT //

(1) 17-inch aluminum (standard)

(2) 18-inch polished aluminum (available)

CHARGER R/T //

(2) 18-inch polished aluminum (standard)

CHARGER SXT PLUS AND R/T PLUS //

(3) 18-inch chrome-clad aluminum (standard)

CHARGER SXT AWD AND R/T AWD //

(4) 19-inch Satin Carbon aluminum (standard)

R/T MAX, RALLYE APPEARANCE PACKAGE AND WHEELS AND TUNES GROUP //

(5) 20-inch chrome-clad aluminum (standard)

CHARGER R/T ROAD & TRACK //

(5) 20-inch chrome-clad aluminum (standard)

(6) 20-inch forged polished aluminum (available)

BLACKTOP PACKAGE //

(7) 20-inch aluminum Gloss Black (standard)

CHARGER SRT8 //

(8) 20-inch forged aluminum (standard)



CHARGER COLORS

REDLINE 3 COAT PEARL*

BRIGHT SILVER METALLIC

BLACKBERRY PEARL*†

PITCH BLACK

TUNGSTEN METALLIC

BRIGHT WHITE*

BLUE STREAK PEARL*‡

*Not available on Blacktop. †Not available on SRT8® or R/T Road & Track. ‡Late availability.

CHARGER DIMENSIONS LENGTH: 199.9"; HEIGHT: 58.7"; WHEELBASE: 120.1"; TRACK (FRONT/REAR): 62.9"/63.0"



DODGE.COM/LIFE

Check out an extensive line of gifts and gear for the Dodge enthusiast. From authentic apparel to die-cast replica cars for the collector, as well as electronics and office supplies, all lifestyle items are as bold as your Dodge vehicle. Refer to dodge.com/life for current product availability.



[DODGE.COM/CHARGER](https://www.dodge.com/charger)



5 YEAR / 100,000 MILE
POWERTRAIN WARRANTY

DODGE LIFE

Chrysler
Service
Contracts



Uconnect

SiriusXM
SATELLITE RADIO

AUTOMOBILITY
PROGRAM
CHRYSLER | JEEP | DODGE | RAM



^[1]Based on latest available competitive information and *Ward's* Large Regular Vehicle segmentation. ^[2]Based on *Ward's* Large Regular Vehicle segmentation. 2012 EPA estimated 19 city / 31 highway / 23 combined mpg. ^[3]Based on latest available competitive information and *Ward's* Large Regular Vehicle segmentation. EPA estimated 16 city / 25 highway mpg. ^[4]No system, no matter how sophisticated, can repeal the laws of physics or overcome careless driving actions. Performance is limited by available traction, which snow, ice, and other conditions can affect. When the ESC warning lamp flashes, the driver needs to use less throttle and adapt speed and driving behavior to prevailing road conditions. Always drive carefully, consistent with conditions. Always wear your seat belt. ^[5]Sirius services require subscriptions, sold separately after 12-month trial included with vehicle purchase. See our Customer Agreement for complete terms at siriusxm.com. If you decide to continue your SiriusXM service at the end of your subscription trial, the plan you choose will automatically renew and bill at then-current rates until you call SiriusXM at 1-866-635-2349 to cancel. Programming subject to change. Sirius satellite service available only to those at least 18 years of age in the 48 contiguous United States and D.C., with Sirius also available in PR (with coverage limitations). Traffic information not available in all markets. Go to www.siriusxm.com/traffic for available coverage. ©2011 SiriusXM Radio Inc. ^[6]Phone must support Bluetooth Phone Book Access Profile (PBAP). ^[7]Requires Uconnect Phone. ^[8]The Uconnect Web feature is not intended for use by the driver while the vehicle is in motion. ^[9]The Advanced Front Air Bags in this vehicle are certified to the new federal regulations for advanced air bags. Children 12 years old and younger should always ride buckled up in a rear seat. Infants in rear-facing child restraints should never ride in the front seat of a vehicle with a passenger front air bag. All occupants should always wear their lap and shoulder belts properly. ^[10]Always sit properly with the head restraint properly adjusted. Never place anything in front of the head restraint. ^[11]Always check visually for vehicles prior to changing lanes. ^[12]Always check entire surroundings before backing up. ^[13]ACC is a driver's convenience system, not a substitute for active driver involvement. The driver must remain aware of traffic conditions and be prepared to use the brakes to avoid collisions. ^[14]FCW system is solely an alert system for the front of the vehicle which does not take any actions to change the vehicle dynamics to avoid a collision, not a substitute for active driver involvement. The driver must remain aware of traffic conditions and be prepared to use the brakes to avoid collisions.

5-YEAR/100,000-MILE POWERTRAIN LIMITED WARRANTY Transferable. See your dealer for complete details and a copy of the 5-Year/100,000-Mile Powertrain Limited Warranty. **3/36 BASIC LIMITED WARRANTY** Dodge vehicles are covered by a Chrysler Group LLC 3-Year or 36,000-Mile Basic Limited Warranty. See your dealer for a copy of this limited warranty. Excludes normal maintenance and wear items. Enhance your Dodge Charger with **AUTHENTIC DODGE ACCESSORIES BY MOPAR**. They're designed specifically for your vehicle, for exceptional fit, finish, and performance. Visit your dealership or mopar.com. With **UCONNECT**[®] you're always connected – to people, places, music, movies, and the Internet. **SiriusXM™ SATELLITE RADIO** Get over 130 channels, including commercial-free music plus the best sports, news, talk, comedy, and entertainment. Welcome to the world of satellite radio. Factory-installed SiriusXM Satellite Radio includes a one-year subscription. For more information, go to siriusxm.com. **DODGE LIFE** is a handpicked collection of items bearing the powerful Dodge name – from Motorsports apparel and collectible die-cast models to the hottest items for work and weekend fun. It's all found at dodge.com/life. Chrysler Group LLC's **AUTOMOBILITY** program provides aftermarket reimbursement incentives on adaptive vehicle upfit equipment in order to help provide safe and reliable vehicle modifications to enhance accessibility for all people. For more information, call (800) 255-9877. **CHRYSLER SERVICE CONTRACTS**. Chrysler Group LLC has a vested interest in your satisfaction and owner experience with your new Dodge vehicle. Chrysler Group LLC Service Contracts offer extended service plans to help ensure you'll enjoy your vehicle for many years down the road. For more information on comprehensive vehicle coverage, see your Dodge dealer, call (800) 442-2666, or visit dodge.com/csc. **DODGE® MASTERCARD®**. Earn 3 points on qualifying purchases made at Chrysler Group LLC dealerships, 2 points per \$1 on qualifying travel purchases and 1 point per \$1 on qualifying purchases everywhere else with the new Dodge MasterCard. Points may be redeemed at your local dealership for cash off your new or used vehicle, accessories, parts, or service – including your next oil change. Or choose from hundreds of other rewards, including travel, cash back to your account, merchandise, or gift cards.* For more information or to apply, visit DodgeCard.com *Complete details, including restrictions, limitations, and exclusions, will be available when you become a Cardmember. This card is issued by First Bankcard, a division of First National Bank of Omaha, pursuant to a license by MasterCard International Incorporated.

About this catalog: Since the time of printing, some of the information you'll find in this catalog may have been updated. Ask your dealer for details. Some of the equipment shown or described throughout this catalog is available at extra cost. Specifications, descriptions, illustrative materials, and all competitive comparisons contained herein are as accurate as known at the time this publication was approved for printing. Chrysler Group LLC reserves the right to discontinue models at any time or change specifications without notice and without incurring obligation. All options are required in combination with other options. For the price of the model with the equipment you desire, or verification of specifications contained here, see your Dodge dealer. Dodge, Charger, HEMI, R/T, Mopar, ParkSense, ParkView, Pentastar, Sentry Key, SRT, SXT, SRT8, and Uconnect are registered trademarks and Uconnect Touch and Blacktop are trademarks of Chrysler Group LLC. Sirius, XM, and all related marks and logos are trademarks of SiriusXM Radio Inc. and its subsidiaries. The Harman Kardon logo is a registered trademark of Harman International Industries, Inc. Facebook is a registered trademark of Facebook, Inc. The Twitter logo is a service mark of Twitter, Inc. YouTube is a trademark of Google Inc. Bluetooth is a registered trademark of Bluetooth SIG, Inc. iPod is a registered trademark of Apple Inc. All rights reserved. Garmin and the Garmin logo are registered trademarks of Garmin Ltd. or its subsidiaries and are registered in one or more countries, including the United States. SmartBeam is a trademark of Gentex Corporation. Katzkin and the Katzkin logo are registered trademarks of Katzkin Leather Interiors, Inc. MasterCard is a registered trademark of MasterCard International, Incorporated. All rights reserved. Dr. Dre, Beats, and the B logo are trademarks of Beats Electronics, LLC. © 2011 Chrysler Group LLC. All rights reserved.



DODGE.COM // 800-4ADODGE

DODGE IS A REGISTERED TRADEMARK OF CHRYSLER GROUP LLC.

DODGE 